

PLA-400/402

PowerLine Ethernet Adapter Series

User's Guide

Version 1.00

03/2007

Edition 2



About This User's Guide

Intended Audience

This manual is intended for people who want to configure the PLA-400/402 using the PLA-4xx Series Configuration Utility. You should have your basic Internet access or home network already set up.

Related Documentation

- Quick Start Guide
The Quick Start Guide is designed to help you get up and running right away. It contains information on making your hardware connections.
- Supporting Disk
Refer to the included CD for support documents.
- ZyXEL Web Site
Please refer to www.zyxel.com for additional support documentation and product certifications.

User Guide Feedback

Help us help you. Send all User Guide-related comments, questions or suggestions for improvement to the following address, or use e-mail instead. Thank you!

The Technical Writing Team,
ZyXEL Communications Corp.,
6 Innovation Road II,
Science-Based Industrial Park,
Hsinchu, 300, Taiwan.

E-mail: techwriters@zyxel.com.tw

Document Conventions

Warnings and Notes

These are how warnings and notes are shown in this User's Guide.



Warnings tell you about things that could harm you or your device.





Notes tell you other important information (for example, other things you may need to configure or helpful tips) or recommendations.

Syntax Conventions

- The PLA-400 and PLA-402 may be referred to as the “PLA-400/402”, the “device” or the “ethernet adapter” in this User's Guide.
- Product labels, screen names, field labels and field choices are all in **bold** font.
- A key stroke is denoted by square brackets and uppercase text, for example, [ENTER] means the “enter” or “return” key on your keyboard.
- “Enter” means for you to type one or more characters and then press the [ENTER] key. “Select” or “choose” means for you to use one of the predefined choices.
- A right angle bracket (>) within a screen name denotes a mouse click. For example, **Maintenance > Log > Log Setting** means you first click **Maintenance** in the navigation panel, then the **Log** sub menu and finally the **Log Setting** tab to get to that screen.
- Units of measurement may denote the “metric” value or the “scientific” value. For example, “k” for kilo may denote “1000” or “1024”, “M” for mega may denote “1000000” or “1048576” and so on.
- “e.g.,” is a shorthand for “for instance”, and “i.e.,” means “that is” or “in other words”.

Icons Used in Figures

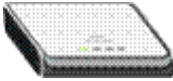
Figures in this User's Guide may use the following generic icons. The PLA-400/402 icon is not an exact representation of your device.

PLA-400/402 	Computer 	Notebook computer 
--	---	--

Safety Warnings



For your safety, be sure to read and follow all warning notices and instructions.

- Do NOT use this product near water, for example, in a wet basement or near a swimming pool.
- Do NOT expose your device to dampness, dust or corrosive liquids.
- Do NOT store things on the device.
- Do NOT install, use, or service this device during a thunderstorm. There is a remote risk of electric shock from lightning.
- Connect ONLY suitable accessories to the device.
- Do NOT open the device or unit. Opening or removing covers can expose you to dangerous high voltage points or other risks. ONLY qualified service personnel should service or disassemble this device. Please contact your vendor for further information. Make sure to connect the cables to the correct ports.
- Place connecting cables carefully so that no one will step on them or stumble over them.
- Always disconnect all cables from this device before servicing or disassembling.
- Use ONLY an appropriate power adaptor or cord for your device.
- Connect the power adaptor or cord to the right supply voltage (for example, 110V AC in North America or 230V AC in Europe).
- Do NOT allow anything to rest on the power adaptor or cord and do NOT place the product where anyone can walk on the power adaptor or cord.
- Do NOT use the device if the power adaptor or cord is damaged as it might cause electrocution.
- If the power adaptor or cord is damaged, remove it from the power outlet.
- Do NOT attempt to repair the power adaptor or cord. Contact your local vendor to order a new one.
- Do not use the device outside, and make sure all the connections are indoors. There is a remote risk of electric shock from lightning.
- Do NOT obstruct the device ventilation slots, as insufficient airflow may harm your device.
- If you wall mount your device, make sure that no electrical lines, gas or water pipes will be damaged.

PLA-402 models only:

- Make sure that the cable system is grounded so as to provide some protection against voltage surges.

This product is recyclable. Dispose of it properly.

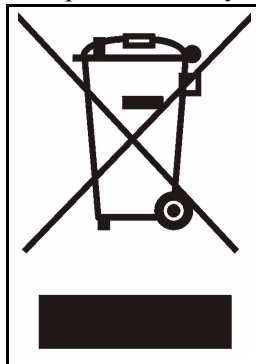

Table of Contents

About This User's Guide	3
Document Conventions.....	4
Safety Warnings.....	5
Table of Contents.....	7
List of Figures	9
List of Tables.....	11
Chapter 1	
Introducing the PLA-400/402	13
1.1 Overview	13
1.1.1 Expand Your Network with the PLA-400	13
1.1.2 Expand Your Network with the PLA-402	14
1.2 Managing the PLA-400/402	14
1.2.1 Passwords in the Power Line Network	15
Chapter 2	
Installing the Configuration Utility	17
2.1 Overview of the Installation Process	17
2.2 Installing the Utility	17
Chapter 3	
Managing Your PLA-400/402.....	23
3.1 Overview	23
3.1.1 Power Line Network Security	24
3.1.2 Device Access Key (DAK)	24
3.2 Starting the Configuration Utility	24
3.3 Configuration Screen	24
3.4 Firmware Screen	26
3.5 Network Info Screen	28
3.6 About Screen	29
Chapter 4	
LEDs and Troubleshooting	31
4.1 LEDs	31
4.2 Power and LED Problems	32

4.3 Configuration Utility	32
Appendix A Product Specifications	35
Appendix B Legal Information	39
Appendix C Customer Support	43
Index.....	47

List of Figures

Figure 1 Expand Your Network with the PLA-400	13
Figure 2 Expand Your Network with the PLA-402 over Coaxial Cable Wiring	14
Figure 3 .NET Framework Installation Prompt	18
Figure 4 Microsoft's Agreement	18
Figure 5 .NET Framework Installation Process	19
Figure 6 Microsoft's Agreement	19
Figure 7 InstallShield Wizard Start Screen	19
Figure 8 Customer Information Input	20
Figure 9 Install Destination Folder	20
Figure 10 Install Begin Screen	21
Figure 11 Restart Screen	21
Figure 12 Example Network Setup	23
Figure 13 PLA-4xx Series Configuration Utility Icon	24
Figure 14 Configuration Screen	25
Figure 15 Firmware Screen	27
Figure 16 Network Info Screen	28
Figure 17 About Screen	29
Figure 18 LEDs	31
Figure 19 Wall-mounting Example	37
Figure 20 Masonry Plug and M4 Tap Screw	37
Figure 21 RJ-45 Connector Pins	38

List of Tables

Table 1 Password Summary	15
Table 2 Configuration Screen	25
Table 3 Firmware Screen	27
Table 4 Network Info Screen	28
Table 5 About Screen	29
Table 6 LEDs	31
Table 7 Hardware Specifications	35
Table 8 Firmware Specifications	35
Table 9 Performance	36
Table 10 RJ-45 Connector Pin Assignments	38

Introducing the PLA-400/402

This chapter introduces the main applications and features of the PLA-400 and PLA-402 HomePlug AV compliant power line adapters. It also introduces how to manage the PLA-400/402.

1.1 Overview

The HomePlug AV (Audio/Video) standard specifies how network devices communicate using standard electrical wiring. This section shows you typical applications for your PLA-400 and PLA-402 PowerLine Ethernet Adapters. See [Appendix A on page 35](#) for detailed product specifications for each model.

1.1.1 Expand Your Network with the PLA-400

The PLA-400 plugs into an ordinary outlet to easily extend a cable or DSL broadband connection or existing Ethernet (LAN) network to any other electrical outlet in any room of a house, all without the need for any new cabling. Devices can securely communicate with each other with data transfer rates of up to 200 Mbps over the power line. The PLA-400/402s use 128-bit Advanced Encryption Standard (AES) to ensure safe transfer of information.

Figure 1 Expand Your Network with the PLA-400

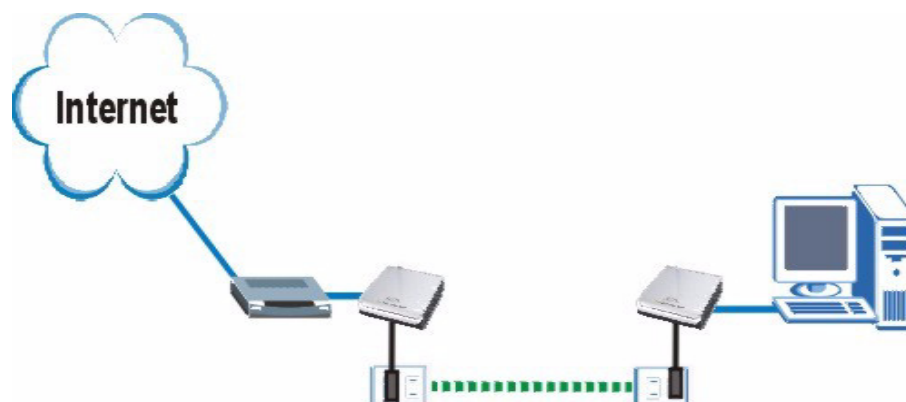

Connect your PLA-400 to a modem, router or switch and plug it into an ordinary power outlet in your home. Plug a second PLA-400 into another power outlet and connect a computer to the PLA-400 for Internet access. Your network can be further expanded by plugging additional PLA-400s into other outlets in your home and connecting other computers or network devices (for example a printer) to them.

Refer to your Quick Start Guide for hardware connection information. Refer to [Appendix A on page 35](#) for wall mounting instructions.

1.1.2 Expand Your Network with the PLA-402

The PLA-402 allows you to be more flexible in expanding your network by adding the coaxial cable capability.

Figure 2 Expand Your Network with the PLA-402 over Coaxial Cable Wiring

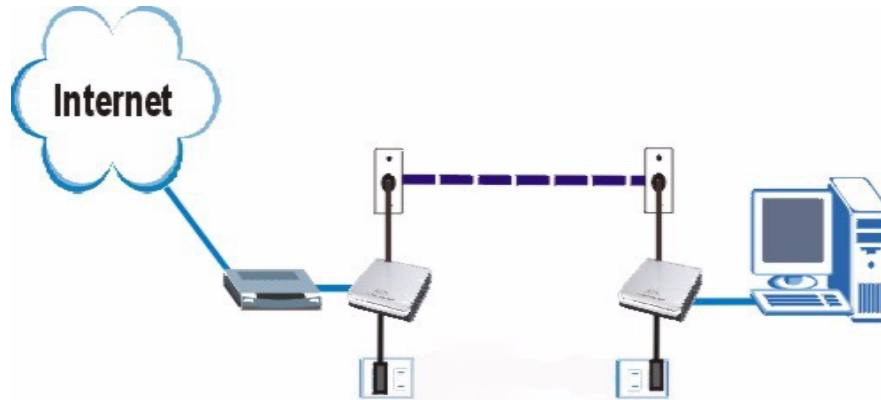

Connect your PLA-402 to a modem, router or switch and plug it into a coaxial cable outlet in your home. Plug a second PLA-402 into another outlet and connect a computer to the PLA-402 for Internet access. Your network can be further expanded by plugging additional PLA-402s into other outlets in your home and connecting other computers or network devices (for example a printer) to them.

Refer to your Quick Start Guide for hardware connection information. Refer to the [Appendix A on page 35](#) for wall mounting instructions.

1.2 Managing the PLA-400/402

Use the **PLA-4xx Series Configuration Utility** to manage and set up security on the PLA-400/402 or other HomePlug AV compliant power line adapters. Although the PLA-400/402 is a “plug-and-play” network expanding solution there are situations when you might want to enable security on the power line network in your home. The reasons include:

- 1 To ensure privacy of your communication. When you use the PLA-400/402 and other power line adapters, the electrical wiring in your home becomes an extension of your Ethernet network. Your network traffic flows freely within the electrical circuit of your home and is bounded in most cases by a power meter.
Without security (encryption) your information is accessible to anyone using a power line adapter on the same electrical circuit. In some cases, a circuit can be shared by more than one household.
To prevent compromising your network security, you can create a private network. A private network uses a secret password to make sure that only permitted power line adapters can communicate in your network. See [Section 3.1.1 on page 24](#) for information on setting up a private network.
- 2 To create multiple power line networks. Multiple power line networks can coexist on a single power line circuit. You might want to implement multiple power line networks in a small office environment where you have two separate Ethernet networks.

Connect one power line adapter to a router or switch on the first Ethernet network and assign a password (for example “Password1”) to this power line adapter. Add additional power line adapters to your network by plugging them into your power line outlets and assigning them “Password1”. This completes the configuration of your first power line network.

Connect another power line adapter to a router or switch on the second Ethernet network and assign a different password (for example “Password2”) to this power line adapter. Again, add additional power line adapters and assign them “Password2”.

You now have two private networks on your power line circuit. Information is not shared between the two networks as only power line adapters with the same password can communicate with each other.

1.2.1 Passwords in the Power Line Network

You use two types of passwords in the power line network. The following table describes the differences between the passwords.

Table 1 Password Summary

PASSWORD	DESCRIPTION
Private Network Password	All power line adapters that follow the HomePlug AV standard are shipped with the same power line network password “HomePlugAV”. Change this password via the PLA-4xx Series Configuration Utility to create a private network. See Section 3.3 on page 24 .
DAK (Data Access Key) Password	In order to manage the power line adapters on your power line network you must enter the adapters’ DAK password in the PLA-4xx Series Configuration Utility . This password is printed on the power line adapter itself. You don’t need to add the password for the power line adapter directly connected to the computer running the configuration utility (local power line adapter), you only have to add the remote power line adapters’ passwords (those on your circuit, but not directly connected to your computer).

Installing the Configuration Utility

This chapter guides you through the installation of the configuration utility for your PLA-400/402.

2.1 Overview of the Installation Process

The installation of the configuration utility does the following:

- 1 Checks for and installs Microsoft's .NET Framework version 1.1 software on your computer. This software is necessary for the installation of the **PLA-4xx Series Configuration Utility**. If you already have .NET Framework version 1.1 installed on your computer this step will be skipped.
- 2 Installs ZyXEL's **PLA-4xx Series Configuration Utility**. This utility allows you to manage the network password (See [Section 3.1.1 on page 24](#) for more information) or upload firmware on your power line adapters. You can also use this utility to view the devices recognized on your power line network.



At the time of writing the utility is only compatible on Microsoft Windows XP and Microsoft Windows Vista (32-bit version) operating systems.

2.2 Installing the Utility

Follow the steps below to install .NET Framework version 1.1 and the **PLA-4xx Series Configuration Utility** on your computer.

- 1 Insert the included CD-ROM into your computer's CD-ROM drive. The Setup utility runs automatically. Alternatively this can also be done manually by double clicking the **setup.exe** file on the CD. A prompt appears asking you to install the .NET Framework version 1.1. Click **Yes** to continue with the installation.

Figure 3 .NET Framework Installation Prompt

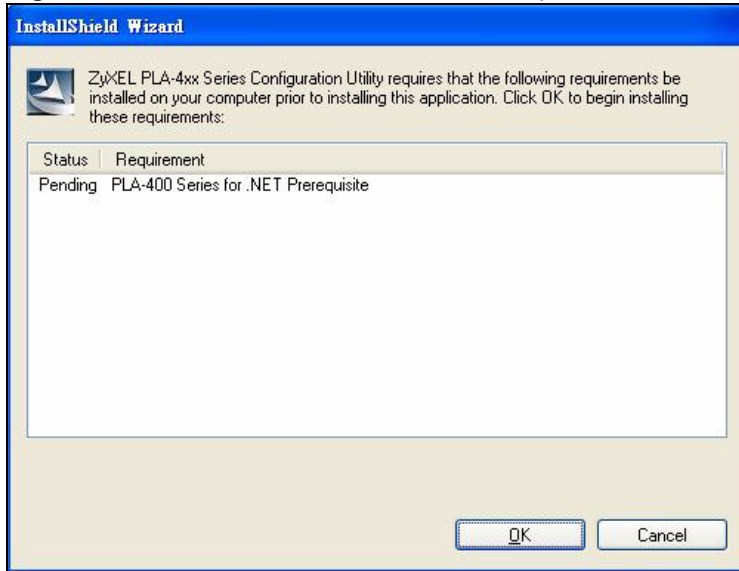

2 Review Microsoft's **License Agreement**, select **I agree** and click **Install** to proceed.

Figure 4 Microsoft's Agreement

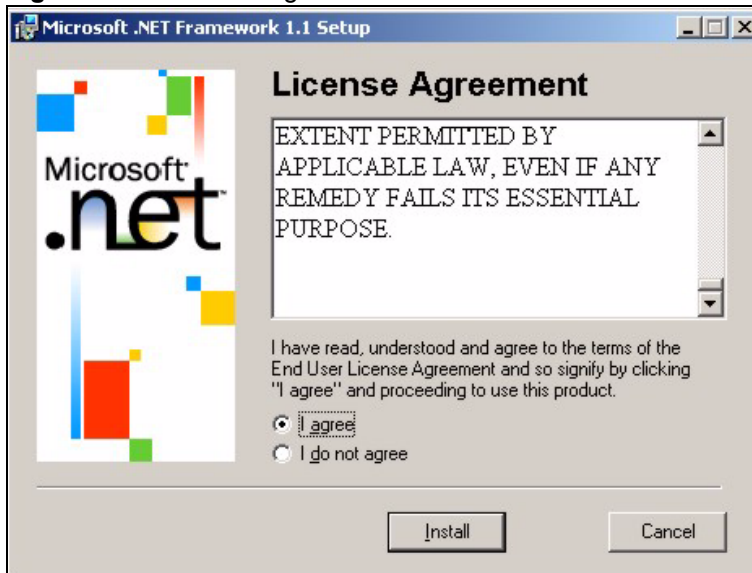

3 The next screen allows you to see the progress of the installation.

Figure 5 .NET Framework Installation Process

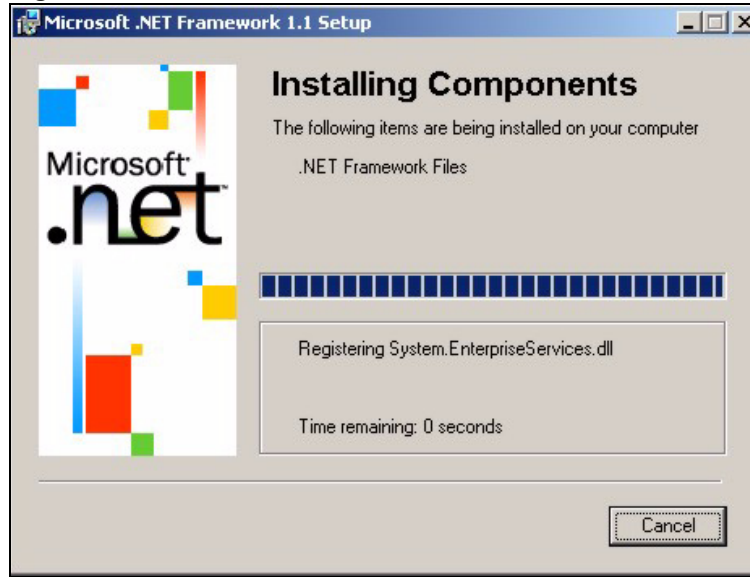

- 4 Click **OK** to complete the installation process.

Figure 6 Microsoft's Agreement

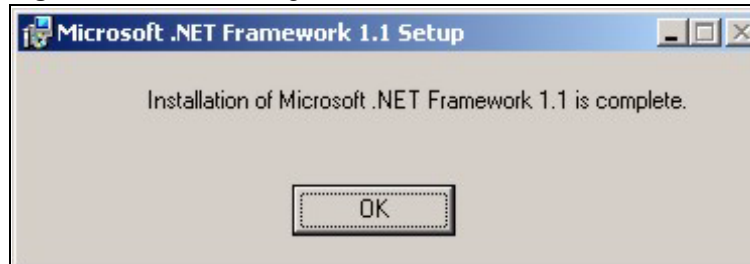

- 5 The Setup utility runs automatically. Click **Yes** or **Next** to continue through the initial screen. Click **Cancel** only if you want to abort the installation.

Figure 7 InstallShield Wizard Start Screen

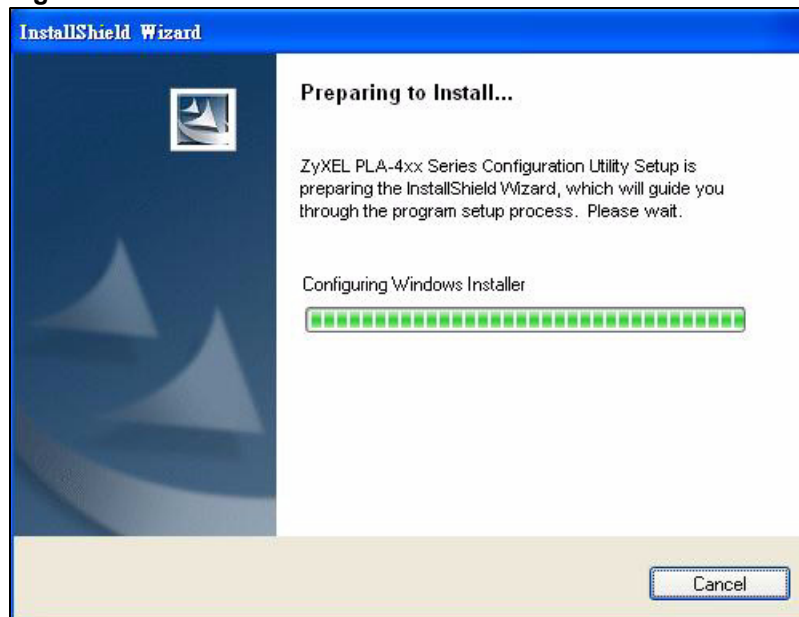

- 6 Fill in the **User Name** and **Company Name** fields (optional). If you want the utility to be only available to the currently logged in user, select **Only for me(...)**. Otherwise, click **Next** to continue and allow all users to use the configuration utility.

Figure 8 Customer Information Input

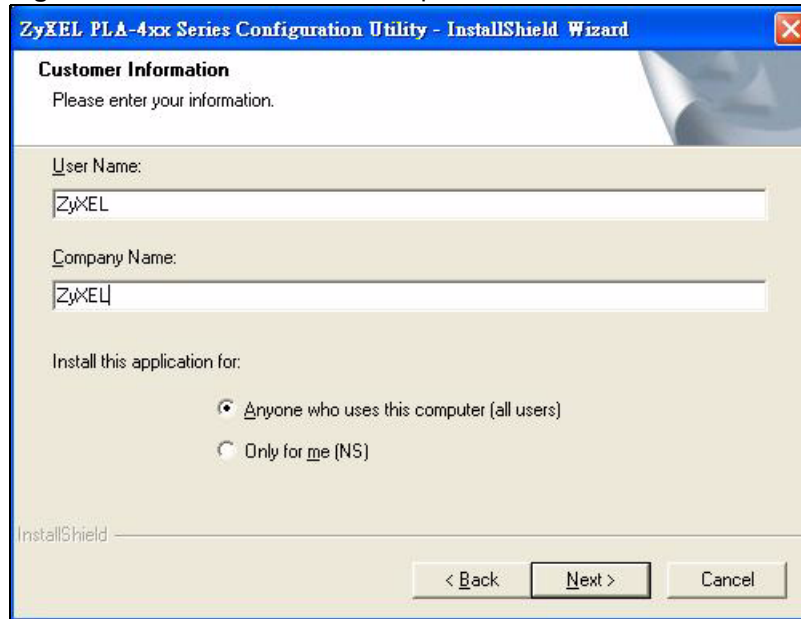

- 7 Click **Next** to install the utility to the default folder, or click **Change** to specify a different location on your computer.

Figure 9 Install Destination Folder

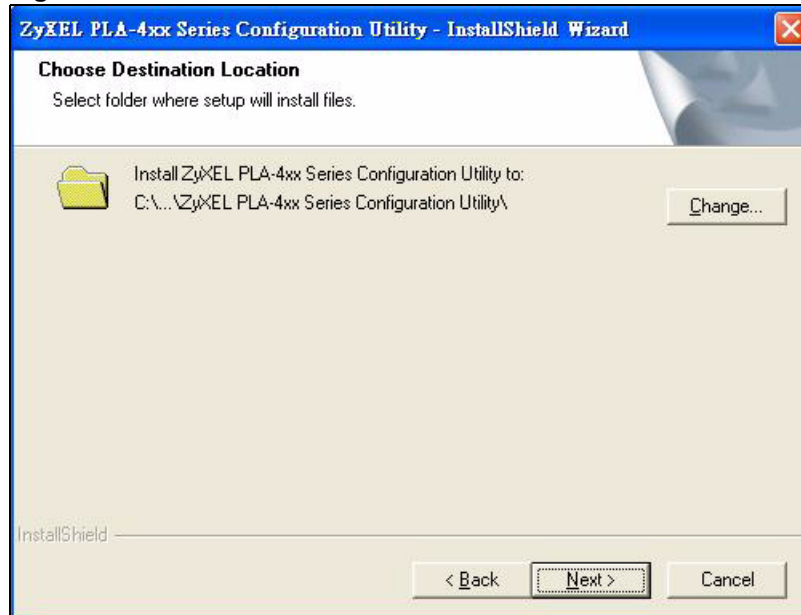

- 8 The installation wizard is ready to begin the installation. Review your current settings and click **Install** to proceed, or **Cancel** to exit the wizard. Alternatively, click **Back** to change the destination of the installation files or user information.

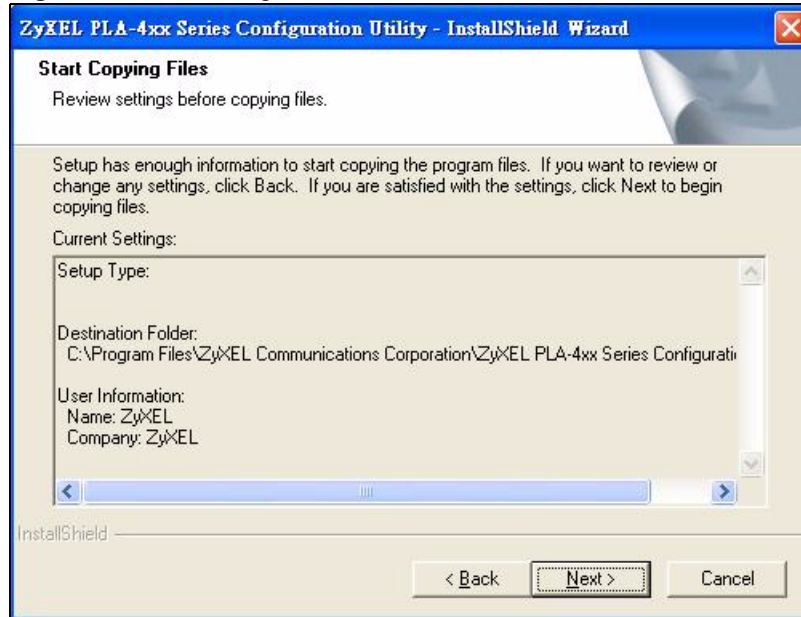
Figure 10 Install Begin Screen

- 9 When the installation is finished, a screen appears to confirm the **InstallShield Wizard** has successfully installed the **PLA-4xx Series Configuration Utility** to your computer. Click **Finish** to exit the wizard and restart your computer.

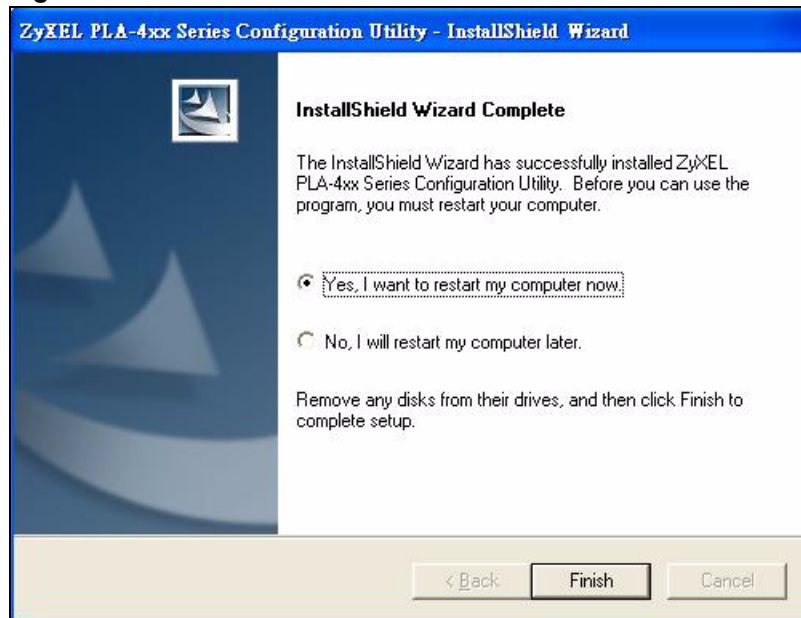
Figure 11 Restart Screen

If you select “No, I will restart my computer later”, you will not be able to launch the utility until after a restart of your computer.

Managing Your PLA-400/402

This chapter shows you how to use the configuration utility to manage security and update software on the PLA-400/402s in your power line network.

3.1 Overview

The PLA-400/402 is designed as a plug-and-play network expanding solution. This means that once you complete your hardware connections, the PLA-400/402s in your network (without additional configuration) are able to communicate with each other by sending and receiving information over your home's electrical wiring (**A**). For the PLA-402 models you have the option to use coaxial cables (**B**) to expand your network.

In this User's Guide the electrical wiring network and coaxial cable network are both referred to as the "power line network".

Figure 12 Example Network Setup

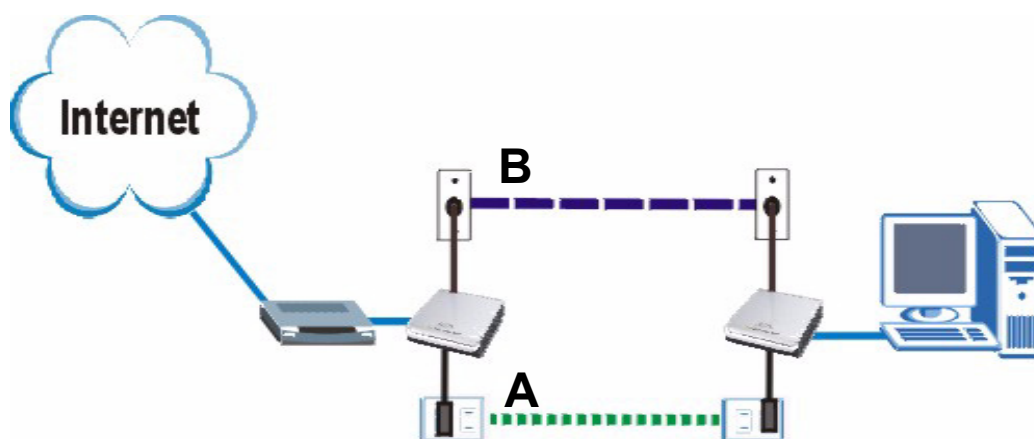

All HomePlug AV compliant power line adapters within range can join your network. The range varies depending on the quality of your home's wiring. In the case of coaxial cable this can extend beyond the boundary of your home (for example your neighbor's house or apartment).



See [Section 3.1.1 on page 24](#) for more information on enhancing your power line network security.

3.1.1 Power Line Network Security

When the PLA-400/402s communicate with each other, they use encryption to protect the information that is sent in the power line network. Encryption is like a secret code. If you do not know the secret code, you cannot understand the message. The HomePlug AV standard uses 128-bit AES (Advanced Encryption Standard) to safely transmit data between power line adapters.

For the power line adapters to communicate with each other they all need to use the same network password. This password allows the power line adapters to understand the encrypted information sent in the power line network.

By default the PLA-400/402s are all configured with the password **HomePlugAV**, this allows you to simply plug the devices in and not worry about setting up security. If you want to enhance the security on your power line network, you can change the network password on the power line adapters you want to allow to communicate in your power line network.

3.1.2 Device Access Key (DAK)

In order to manage the power line adapters on your power line network you must enter the adapters' password in the **PLA-4xx Series Configuration Utility**. This password is called the DAK (Device Access Key) password. This password is printed on the power line adapter itself.

You don't need to enter the DAK password for the power line adapter directly connected to the computer running the configuration utility (local power line adapter), you only have to add the remote power line adapters' passwords (those in your power line network, but not directly connected to your computer).

3.2 Starting the Configuration Utility

To launch the **PLA-4xx Series Configuration Utility** simply double click on the configuration icon on your desktop.

Figure 13 PLA-4xx Series Configuration Utility Icon



Alternatively, start the utility by browsing to it from the start menu. Click **Start > Programs > ZyXEL Communication Corporation > PLA-4xx Series Configuration Utility**.

3.3 Configuration Screen

Use the **Configuration** screen to see which devices are recognized by your power line network, gain access to managing remote devices (those not directly connected to the computer running the configuration utility) and change the power line network password. This screen opens up when you launch the configuration utility.



Use the  icon to view online help information in each screen of the utility.

Figure 14 Configuration Screen

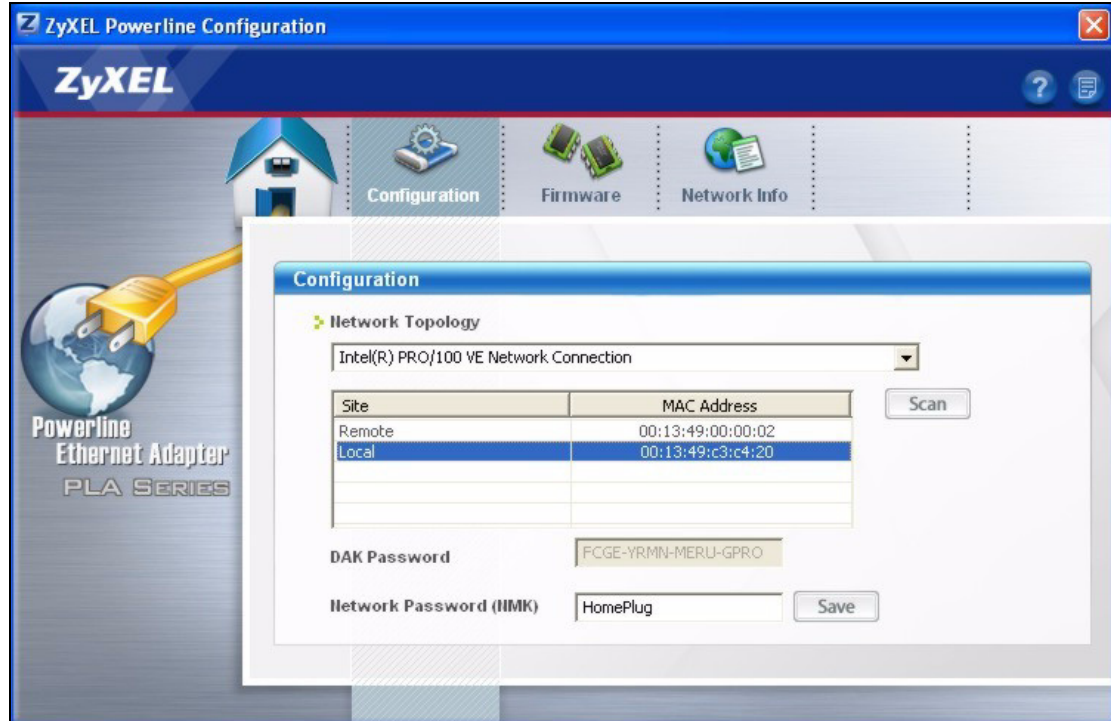

The following table describes the labels in this screen.

Table 2 Configuration Screen

LABEL	DESCRIPTION
Network Topology	Use this to select which power line network information is displayed. Different power line networks are identified by the Ethernet interface (network card) connected directly to the PLA-400/402. Typically there is only one connection, however, if your computer has two network cards and both are connected to a PLA-400/402 then you have two power line networks.
<p>The fields described below are used to identify the PLA-400/402s and other power line adapters recognized on the power line network. The configuration utility automatically updates this information every 10 seconds. Click Scan to refresh the information in these fields (immediately).</p> <p>Note: Only devices which share the same network password are displayed in this table.</p>	
Site	<p>This field displays</p> <ul style="list-style-type: none"> Local, if it is identifying the PLA-400/402 directly connected to the computer running the configuration utility. Remote, if it is a power line adapter in your power line network but not directly connected to the computer running the configuration utility.
MAC Address	This is a read-only field which shows the MAC address of the power line adapter you are configuring. You can find the MAC address of your PLA-400/402 displayed on a sticker on the bottom of your device.

Table 2 Configuration Screen (continued)

LABEL	DESCRIPTION
DAK Password	<p>DAK (Device Access Key) password is used to verify that you are authorized to perform changes on a remote device. You can find the DAK password printed on a sticker on the bottom of your PLA-400/402.</p> <p>Select the remote power line adapter you want to manage by clicking the MAC address which corresponds to it in the MAC Address column. Enter the DAK Password value and click Save.</p> <p>Note: You must enter the DAK Password value exactly as it is printed on the label (all caps and with dashes “-”).</p>
Network Password	<p>The default network password of PLA-400/402s is “HomePlugAV”. The PLA-400/402s use the same network password to recognize and communicate with each other over the power line network. If you change the password of one device on the network, it will no longer be recognized as part of that network.</p> <p>If you change the network password, make sure you change the password for all of the power line adapters that you want to be part of your power line network.</p> <p>The network password can be from 1 to 64 alphanumeric characters in length; spaces are not allowed.</p>
Save	<p>Click this to apply your changes. The new Network Password is applied to the selected power line adapter.</p> <p>Note: You must enter the correct DAK password for the selected power line adapter before you can make changes to it.</p>

3.4 Firmware Screen

Use the **Firmware** screen to update the firmware on the PLA-400/402 directly connected to the computer running the configuration utility.

Firmware is the software which is embedded in the PLA-400/402. This software contains processing instructions for how the PLA-400/402 sends and receives information in a secure way.

Parameter Information Block (PIB) is similar to firmware. It contains the most basic operating instructions for the PLA-400/402 such as how to power up and how to load the firmware.

You can check the ZyXEL website for firmware upgrades for your PLA-400/402.



Be sure to upload the correct model firmware as uploading the wrong model firmware may damage your device.

Figure 15 Firmware Screen

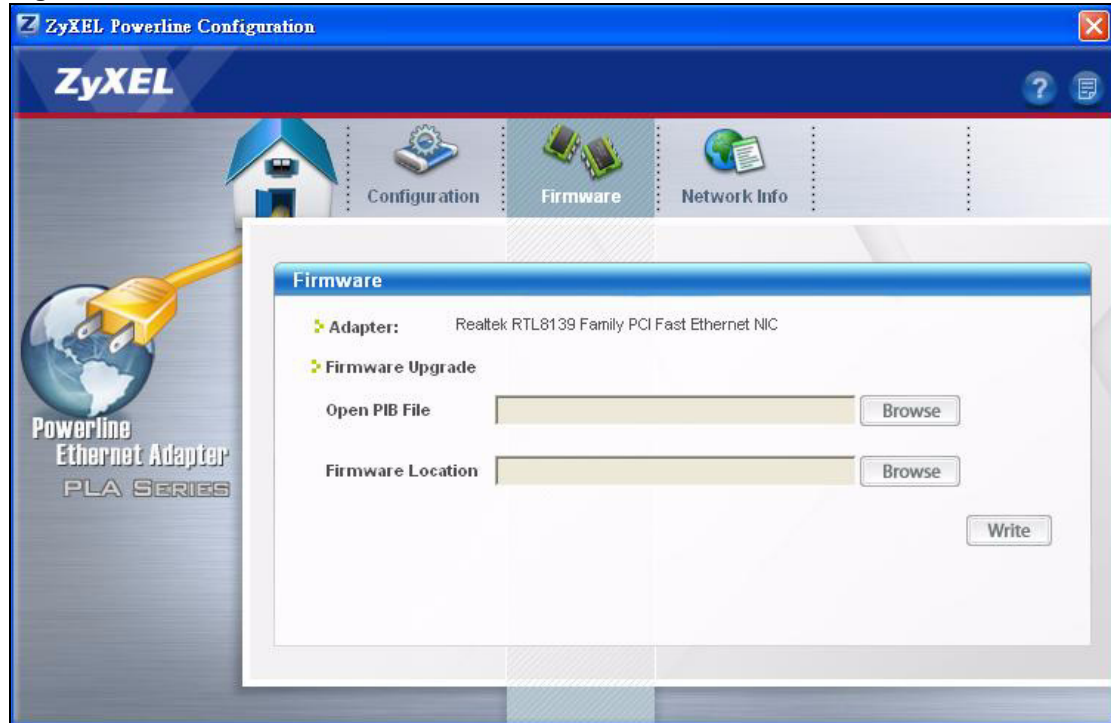

The following table describes the labels in this screen.

Table 3 Firmware Screen

LABEL	DESCRIPTION
Adapter	This field identifies which PLA-400/402 is displayed. The power line adapter is identified by the Ethernet interface (network card) connected directly to the PLA-400/402. The displayed information is the model name of the network card. Typically there is only one connection, however, if your computer has two network cards and both are connected to a PLA-400/402, then you have two power line networks.
Firmware Upgrade	These fields are used when you want to upgrade the firmware or the PIB (Parameter Information Block) file on the local device. The local device is the PLA-400/402 directly connected to the computer running the configuration utility.
Open PIB File	Parameter Information Block (PIB) contains information which tells the PLA-400/402 how to perform basic operating instructions. Click Browse to locate the PIB file you want to upload to the PLA-400/402.
Firmware Location	Click Browse to find the firmware file you want to upload to the PLA-400/402. Note: Remember that you must decompress compressed (.zip) files before you can upload them.
Write	Click this to save the new PIB and firmware files to the PLA-400/402 that is directly connected to the computer running the configuration utility. If the firmware/PIB file upgrade is successful, a confirmation window displays "Commit Successful". Note: If you receive an error message make sure that your paths point to the correct files before you click the Write button.

3.5 Network Info Screen

Use the **Network Info** screen to see the rates at which a specific PLA-400/402 is communicating with other power line adapters on your power line network.

Figure 16 Network Info Screen

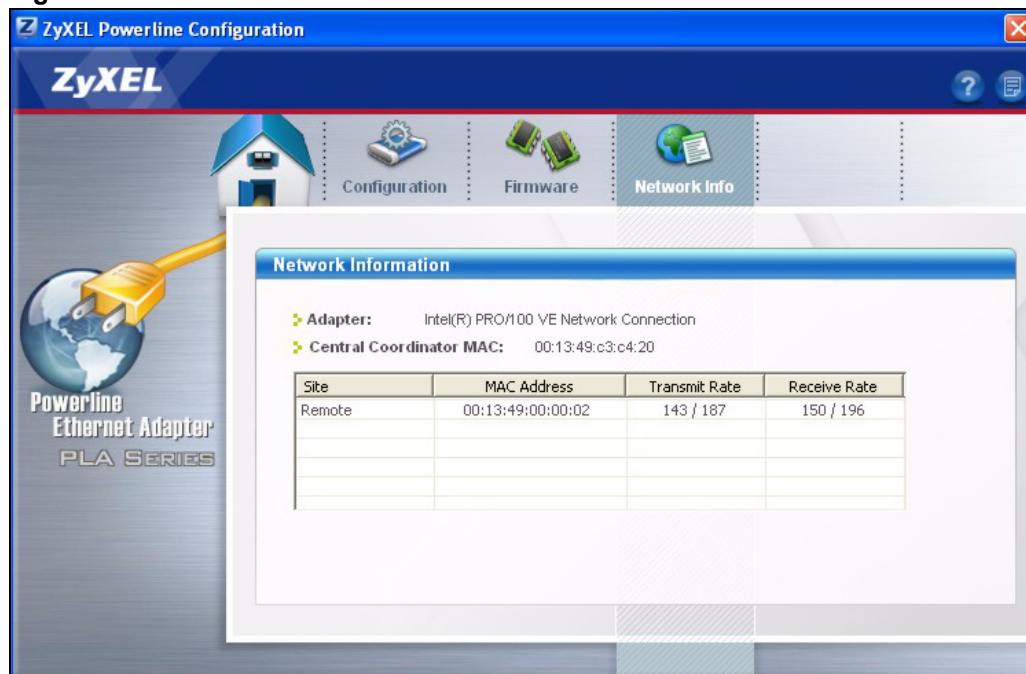

The following table describes the labels in this screen.

Table 4 Network Info Screen

LABEL	DESCRIPTION
Adapter	This field identifies which power line network information is displayed. Different power line networks are identified by the Ethernet interface (network card) connected directly to the PLA-400/402. Typically there is only one connection, however, if your computer has two network cards and both are connected to a PLA-400/402, then you have two power line networks.
Central Coordinator MAC	The Central Coordinator of the power line network is the power line adapter which keeps track of which devices are part of the network as well as synchronizes communication within the power line network. If the Central Coordinator is removed from the power line network then another power line adapter takes its place. This field displays the MAC address of the PLA-400/402 which is the Central Coordinator of the power line network. This power line adapters in your power line network automatically select the Central Coordinator.
<p>The information provided in the following table reflects transmission rate information about the power line adapters which communicate in your power line network.</p> <p>The power line adapters listed in this table are all the power line adapters in your power line network except the power line adapter selected in the Configuration page of the configuration utility. In other words, if the Local power line adapter is selected in the Configuration screen, then this table will display the rates of transmission from the power line adapter connected to the computer running the configuration utility to all the Remote power line adapters.</p>	
Site	<p>This field displays:</p> <ul style="list-style-type: none"> Local, if it is the PLA-400/402 directly connected to the computer running the configuration utility. Remote, if it is a PLA-400/402 in your power line network but not directly connected to the computer running the configuration utility.

Table 4 Network Info Screen (continued)

LABEL	DESCRIPTION
MAC Address	This field displays the MAC address of your power line adapter. The MAC address of your power line adapter can be found by looking at the label on your device. It consists of six pairs of hexadecimal characters (hexadecimal characters are “0-9” and “a-f”). In the case of the PLA-400/402, this label is on the bottom of the device.
Transmit Rate	This field displays how fast information is sent from the power line adapter selected in the Configuration screen to this power line adapter. The rate is given in the following format: “application data transmission rate / raw data transmission rate”. Application data reflects more accurately how fast devices are transmitting application relevant traffic (for example Internet Protocol (IP) traffic). Raw data refers to the whole payload of the packets transmitted across the power line network.
Receive Rate	This field displays how fast information is received from the power line adapter selected in the Configuration screen to this power line adapter. The rate is given in the following format: “application data transmission rate / raw data transmission rate”. Application data reflects more accurately how fast devices are transmitting application relevant traffic (for example Internet Protocol (IP) traffic). Raw data refers to the whole payload of the packets transmitted across the power line network.

3.6 About Screen



Use the **About** screen to view information regarding the configuration utility and firmware version of the PLA-400/402 you are connected to. Click the  icon in the top right corner of the utility to view the **About** screen.

Figure 17 About Screen

The following table describes the labels in this screen.

Table 5 About Screen

LABEL	DESCRIPTION
Utility version:	This field displays the software version of the configuration utility.
Firmware version	This field displays the firmware version of the device you selected in the Device Selection field of the Configuration screen.
Released	This field displays the date when the firmware was released.
Close	Click the  button in upper right corner to close the About window.

LEDs and Troubleshooting

This chapter describes the LED behavior and offers some suggestions to solve problems you might encounter.

4.1 LEDs

The following figure is the front panel of the PLA-400/402. Use the LEDs to determine if the PLA-400/402 is behaving normally or if there are some problems on your power line network.

Figure 18 LEDs

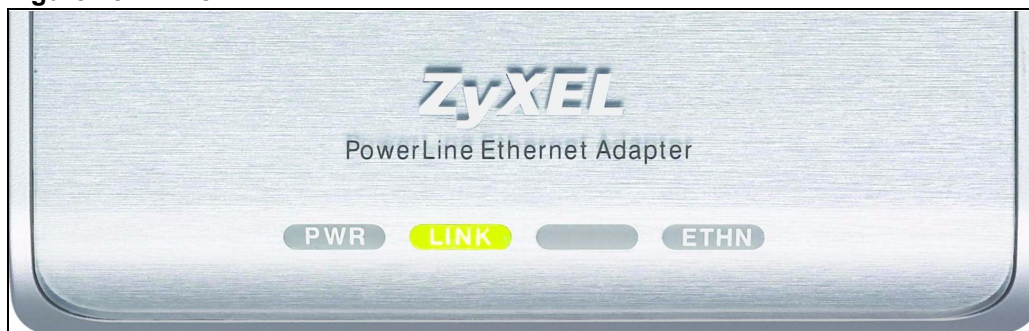

The following table describes the LED behavior.

Table 6 LEDs

LED	STATUS	DESCRIPTION
PWR	On	The PLA-400/402 is on and receiving power.
	Off	The PLA-400/402 is not receiving power.
LINK	On	The POWER port detects another power line adapter.
	Blinking	The PLA-400/402 is communicating with another power line adapter.
	Off	The POWER port is not detecting another power line adapter.
ETHN	On	The LAN port is on and ready and the PLA-400/402 detects a device connected to it.
	Blinking	The PLA-400/402 is communicating with a router, modem, switch or a computer connected to it.
	Off	The PLA-400/402 does not detect any devices connected to its LAN port.

4.2 Power and LED Problems



The PLA-400/402 does not turn on. None of the LEDs turn on.

- 1 Make sure you are using the power adaptor included with the PLA-400/402.
- 2 Make sure the power adaptor is connected to the PLA-400/402 and plugged in to an appropriate power source. Make sure the power source is turned on.
- 3 Disconnect and re-connect the power adaptor to the PLA-400/402.
- 4 If the problem continues, contact the vendor.



The ETHN LED does not turn on.

- 1 Check the hardware connections. See the Quick Start Guide.
- 2 Inspect your cables for damage. Contact the vendor to replace any damaged cables.
- 3 Check the Ethernet adapter on your computer and make sure it's enabled and working properly.
- 4 If the ZyXEL Device is connected to an Ethernet switch or router, make sure the device is working correctly, and that the LAN network is working and configured correctly as well.



The LINK LED does not turn on.

- 1 Use the **PLA-4xx Series Configuration Utility** to detect all other HomePlug devices on your power line network. Make sure that the network password is the same on all of your power line adapters.
- 2 Try plugging a second HomePlug AV adapter into an adjacent outlet (to your PLA-400/402) and see if the **LINK** LED lights up.

4.3 Configuration Utility



The PLA-4xx Series Configuration Utility displays an error during installation.

- Make sure your computer is using Windows XP operating system. At the time of writing, this is the only compatible operating system for the configuration utility.



The PLA-4xx Series Configuration Utility does not display all or any of my devices.

- 1 Make sure all the power line adapters you are using are HomePlug AV compliant.
- 2 Inspect the LEDs on your PLA-400/402 and make sure that the **ETHN** and **LINK** LEDs are on or blinking. See [Section 4.2 on page 32](#) for troubleshooting LED related problems.

Product Specifications

The following tables summarize the PLA-400/402's hardware and firmware features.

Table 7 Hardware Specifications

Dimensions (W x D x H)	112 (L) mm x 106 (D) mm x 28.5 mm (H)
Power Input	100 - 240 VAC, 50/60 Hz, 0.12 A
Ethernet Port	Auto-negotiating: 10 Mbps or 100 Mbps in either half-duplex or full-duplex mode. Auto-crossover: Use either crossover or straight-through Ethernet cables.
Operation Temperature	0° C ~ 50° C
Storage Temperature	-20° C ~ 60° C
Operation Humidity	20% ~ 95% Noncondensing
Storage Humidity	20% ~ 95% Noncondensing
Cabling Type	1 x Powerline Power Cord 1 x LAN UTP Category 5 or Better
Network Interface	1 x 10/100M BASE-T Ethernet port with Auto MDI/MDIX 1 x 200 Mbps PowerLine port compliant with HomePlug AV standard PLA-402 model only: 1 Coaxial Cable Port COAX/PWR switch to select transmission method
Distance between the centers of the holes on the device's back.	74 mm
Recommended type of screws for wall-mounting	M4 Tap Screw, see Figure 20 on page 37 .

Table 8 Firmware Specifications

FEATURE	DESCRIPTION
Power Line Network	Supports up to 16 devices communicating on a single network. Support for 64 devices communicating on a single network is planned for future firmware release.
Encryption	128-bit AES Encryption
Frequency Band	1.8 MHz ~ 30 MHz
Certifications	FCC, CE, CUL, UL, HomePlug AV, RoHS
Device Management	Use the PLA-4xx Series Configuration Utility to easily configure the PLA-400/402.

Table 8 Firmware Specifications

FEATURE	DESCRIPTION
Network Password	Change the power line network password to only allow the ethernet adapters you specify to join your network.
Firmware Upgrade	Download new firmware (when available) from the ZyXEL web site and use the configuration utility to install it. Note: Only upload firmware for your specific model!

Table 9 Performance

FEATURE	DESCRIPTION
Throughput over PHYsical Transport Medium (PHY)	Supports up to 200 Mbps in half duplex mode
Throughput over UDP	Supports up to 150 Mbps over in-house power/coaxial lines (LAN port limits to 100 Mbps)
Number of Devices in one power line network	Supports up to 64 devices

Wall-mounting Instructions

Complete the following steps to hang your PLA-400/402 on a wall.



See [Table 7 on page 35](#) for the size of screws to use and how far apart to place them.

- 1 Select a high position on a sturdy wall that is free of obstructions.
- 2 Drill two holes for the screws. The distance between the centers of the holes is listed in the product specifications appendix.



Be careful to avoid damaging pipes or cables located inside the wall when drilling holes for the screws.

- 3 Do not insert the screws all the way into the wall. Leave a small gap of about 0.5 cm between the heads of the screws and the wall.
- 4 Make sure the screws are snugly fastened to the wall. They need to hold the weight of the PLA-400/402 with the connection cables.
- 5 Align the holes on the back of the PLA-400/402 with the screws on the wall. Hang the PLA-400/402 on the screws.

Figure 19 Wall-mounting Example

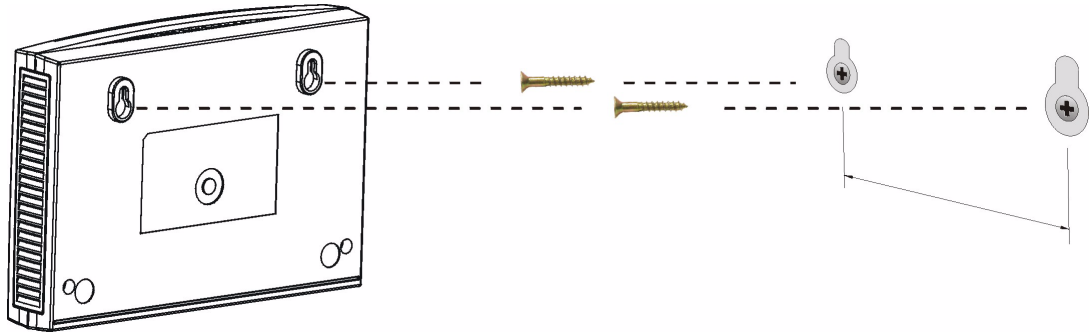

The following are dimensions of an M4 tap screw and masonry plug used for wall mounting. All measurements are in millimeters (mm).

Figure 20 Masonry Plug and M4 Tap Screw

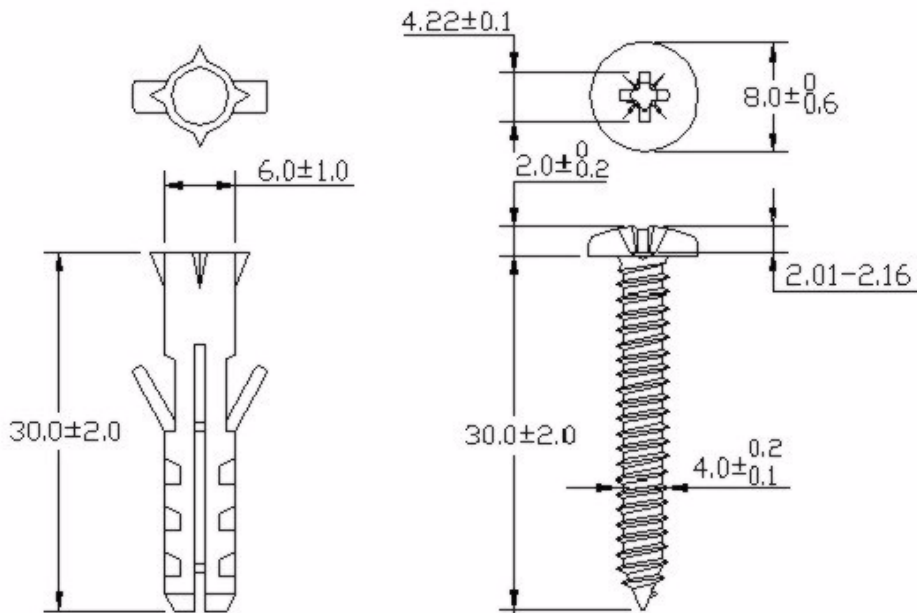

Cable Pin Assignments

RJ-45 Connector Pin Assignments

Figure 21 RJ-45 Connector Pins

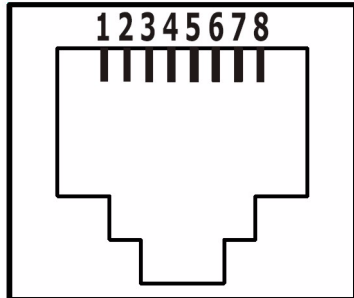

Table 10 RJ-45 Connector Pin Assignments

PIN NO	RJ-45 SIGNAL ASSIGNMENT
1	RxD +
2	RxD -
3	TxD +
4	Not connected
5	Not connected
6	TxD -
7	Not connected
8	Not connected

Legal Information

Copyright

Copyright © 2006 by ZyXEL Communications Corporation.

The contents of this publication may not be reproduced in any part or as a whole, transcribed, stored in a retrieval system, translated into any language, or transmitted in any form or by any means, electronic, mechanical, magnetic, optical, chemical, photocopying, manual, or otherwise, without the prior written permission of ZyXEL Communications Corporation.

Published by ZyXEL Communications Corporation. All rights reserved.

Disclaimer

ZyXEL does not assume any liability arising out of the application or use of any products, or software described herein. Neither does it convey any license under its patent rights nor the patent rights of others. ZyXEL further reserves the right to make changes in any products described herein without notice. This publication is subject to change without notice.

Trademarks

ZyNOS (ZyXEL Network Operating System) is a registered trademark of ZyXEL Communications, Inc. Other trademarks mentioned in this publication are used for identification purposes only and may be properties of their respective owners.

Certifications

Federal Communications Commission (FCC) Interference Statement

The device complies with Part 15 of FCC rules. Operation is subject to the following two conditions:

- This device may not cause harmful interference.
- This device must accept any interference received, including interference that may cause undesired operations.

This device has been tested and found to comply with the limits for a Class B digital device pursuant to Part 15 of the FCC Rules. These limits are designed to provide reasonable protection against harmful interference in a residential installation. This device generates, uses, and can radiate radio frequency energy, and if not installed and used in accordance with the instructions, may cause harmful interference to radio communications. However, there is no guarantee that interference will not occur in a particular installation.

If this device does cause harmful interference to radio/television reception, which can be determined by turning the device off and on, the user is encouraged to try to correct the interference by one or more of the following measures:

- 1 Reorient or relocate the receiving antenna.
- 2 Increase the separation between the equipment and the receiver.
- 3 Connect the equipment into an outlet on a circuit different from that to which the receiver is connected.
- 4 Consult the dealer or an experienced radio/TV technician for help.

CE-Konformität

Das Produkt entspricht den grundlegenden Anforderungen der Richtlinie 1999/5/EG (R&TTE) sowie den übrigen einschlägigen Bestimmungen des FTEG und ist zum Betrieb in der EU und Schweiz vorgesehen. Das Produkt ist eine Einrichtung der Klasse A. Diese Einrichtung kann im Wohnbereich Funkstörungen verursachen; in diesem Fall kann vom Betreiber verlangt werden, angemessene Massnahmen durchzuführen.

Conformité CE

Le produit satisfait aux exigences techniques de la directive 1999/5/CE (R&TTE) et est conçu pour être utilisé au sein de la Communauté européenne et en Suisse. Le produit fait partie de la classe A, ce qui signifie que son exploitation peut entraîner des bruits parasites dans les zones d'habitation ; le cas échéant, l'exploitant peut être tenu de prendre des mesures appropriées pour remédier au dérangement.

Conformità CE

Questo prodotto soddisfa le richieste tecniche della direttiva 1999/5/EG (R&TTE) ed è previsto per il funzionamento nella UE e in Svizzera. Il prodotto è dispositivo della classe A. Questo dispositivo può causare nel settore abitativo dei radiodisturbi.

In questo caso può essere richiesto al gestore di prendere opportune misure.

Notices

Changes or modifications not expressly approved by the party responsible for compliance could void the user's authority to operate the equipment.

This Class B digital apparatus complies with Canadian ICES-003.

Cet appareil numérique de la classe B est conforme à la norme NMB-003 du Canada.

Viewing Certifications

- 1 Go to <http://www.zyxel.com>.
- 2 Select your product on the ZyXEL home page to go to that product's page.
- 3 Select the certification you wish to view from this page.

ZyXEL Limited Warranty

ZyXEL warrants to the original end user (purchaser) that this product is free from any defects in materials or workmanship for a period of up to two years from the date of purchase. During the warranty period, and upon proof of purchase, should the product have indications of failure due to faulty workmanship and/or materials, ZyXEL will, at its discretion, repair or replace the defective products or components without charge for either parts or labor, and to whatever extent it shall deem necessary to restore the product or components to proper operating condition. Any replacement will consist of a new or re-manufactured functionally equivalent product of equal or higher value, and will be solely at the discretion of ZyXEL. This warranty shall not apply if the product has been modified, misused, tampered with, damaged by an act of God, or subjected to abnormal working conditions.

Note

Repair or replacement, as provided under this warranty, is the exclusive remedy of the purchaser. This warranty is in lieu of all other warranties, express or implied, including any implied warranty of merchantability or fitness for a particular use or purpose. ZyXEL shall in no event be held liable for indirect or consequential damages of any kind to the purchaser.

To obtain the services of this warranty, contact ZyXEL's Service Center for your Return Material Authorization number (RMA). Products must be returned Postage Prepaid. It is recommended that the unit be insured when shipped. Any returned products without proof of purchase or those with an out-dated warranty will be repaired or replaced (at the discretion of ZyXEL) and the customer will be billed for parts and labor. All repaired or replaced products will be shipped by ZyXEL to the corresponding return address, Postage Paid. This warranty gives you specific legal rights, and you may also have other rights that vary from country to country.

Registration

Register your product online to receive e-mail notices of firmware upgrades and information at www.zyxel.com for global products, or at www.us.zyxel.com for North American products.

Customer Support

Please have the following information ready when you contact customer support.

Required Information

- Product model and serial number.
- Warranty Information.
- Date that you received your device.
- Brief description of the problem and the steps you took to solve it.

Corporate Headquarters (Worldwide)

- Support E-mail: support@zyxel.com.tw
- Sales E-mail: sales@zyxel.com.tw
- Telephone: +886-3-578-3942
- Fax: +886-3-578-2439
- Web Site: www.zyxel.com, www.europe.zyxel.com
- FTP Site: [ftp.zyxel.com](ftp://ftp.zyxel.com), [ftp.europe.zyxel.com](ftp://ftp.europe.zyxel.com)
- Regular Mail: ZyXEL Communications Corp., 6 Innovation Road II, Science Park, Hsinchu 300, Taiwan

Costa Rica

- Support E-mail: soporte@zyxel.co.cr
- Sales E-mail: sales@zyxel.co.cr
- Telephone: +506-2017878
- Fax: +506-2015098
- Web Site: www.zyxel.co.cr
- FTP Site: [ftp.zyxel.co.cr](ftp://ftp.zyxel.co.cr)
- Regular Mail: ZyXEL Costa Rica, Plaza Roble Escazú, Etapa El Patio, Tercer Piso, San José, Costa Rica

Czech Republic

- E-mail: info@cz.zyxel.com
- Telephone: +420-241-091-350
- Fax: +420-241-091-359
- Web Site: www.zyxel.cz
- Regular Mail: ZyXEL Communications, Czech s.r.o., Modranská 621, 143 01 Praha 4 - Modrany, Česká Republika

Denmark

- Support E-mail: support@zyxel.dk
- Sales E-mail: sales@zyxel.dk
- Telephone: +45-39-55-07-00
- Fax: +45-39-55-07-07
- Web Site: www.zyxel.dk
- Regular Mail: ZyXEL Communications A/S, Columbusvej, 2860 Soeborg, Denmark

Finland

- Support E-mail: support@zyxel.fi
- Sales E-mail: sales@zyxel.fi
- Telephone: +358-9-4780-8411
- Fax: +358-9-4780 8448
- Web Site: www.zyxel.fi
- Regular Mail: ZyXEL Communications Oy, Malminkaari 10, 00700 Helsinki, Finland

France

- E-mail: info@zyxel.fr
- Telephone: +33-4-72-52-97-97
- Fax: +33-4-72-52-19-20
- Web Site: www.zyxel.fr
- Regular Mail: ZyXEL France, 1 rue des Vergers, Bat. 1 / C, 69760 Limonest, France

Germany

- Support E-mail: support@zyxel.de
- Sales E-mail: sales@zyxel.de
- Telephone: +49-2405-6909-69
- Fax: +49-2405-6909-99
- Web Site: www.zyxel.de
- Regular Mail: ZyXEL Deutschland GmbH., Adenauerstr. 20/A2 D-52146, Wuerselen, Germany

Hungary

- Support E-mail: support@zyxel.hu
- Sales E-mail: info@zyxel.hu
- Telephone: +36-1-3361649
- Fax: +36-1-3259100
- Web Site: www.zyxel.hu
- Regular Mail: ZyXEL Hungary, 48, Zoldlomb Str., H-1025, Budapest, Hungary

Kazakhstan

- Support: <http://zyxel.kz/support>
- Sales E-mail: sales@zyxel.kz

- Telephone: +7-3272-590-698
- Fax: +7-3272-590-689
- Web Site: www.zyxel.kz
- Regular Mail: ZyXEL Kazakhstan, 43, Dostyk ave., Office 414, Dostyk Business Centre, 050010, Almaty, Republic of Kazakhstan

North America

- Support E-mail: support@zyxel.com
- Sales E-mail: sales@zyxel.com
- Telephone: +1-800-255-4101, +1-714-632-0882
- Fax: +1-714-632-0858
- Web Site: www.us.zyxel.com
- FTP Site: <ftp.us.zyxel.com>
- Regular Mail: ZyXEL Communications Inc., 1130 N. Miller St., Anaheim, CA 92806-2001, U.S.A.

Norway

- Support E-mail: support@zyxel.no
- Sales E-mail: sales@zyxel.no
- Telephone: +47-22-80-61-80
- Fax: +47-22-80-61-81
- Web Site: www.zyxel.no
- Regular Mail: ZyXEL Communications A/S, Nils Hansens vei 13, 0667 Oslo, Norway

Poland

- E-mail: info@pl.zyxel.com
- Telephone: +48 (22) 333 8250
- Fax: +48 (22) 333 8251
- Web Site: www.pl.zyxel.com
- Regular Mail: ZyXEL Communications, ul. Okrzei 1A, 03-715 Warszawa, Poland

Russia

- Support: <http://zyxel.ru/support>
- Sales E-mail: sales@zyxel.ru
- Telephone: +7-095-542-89-29
- Fax: +7-095-542-89-25
- Web Site: www.zyxel.ru
- Regular Mail: ZyXEL Russia, Ostrovityanova 37a Str., Moscow, 117279, Russia

Spain

- Support E-mail: support@zyxel.es
- Sales E-mail: sales@zyxel.es
- Telephone: +34-902-195-420
- Fax: +34-913-005-345

- Web Site: www.zyxel.es
- Regular Mail: ZyXEL Communications, Arte, 21 5ª planta, 28033 Madrid, Spain

Sweden

- Support E-mail: support@zyxel.se
- Sales E-mail: sales@zyxel.se
- Telephone: +46-31-744-7700
- Fax: +46-31-744-7701
- Web Site: www.zyxel.se
- Regular Mail: ZyXEL Communications A/S, Sjöporten 4, 41764 Göteborg, Sweden

Ukraine

- Support E-mail: support@ua.zyxel.com
- Sales E-mail: sales@ua.zyxel.com
- Telephone: +380-44-247-69-78
- Fax: +380-44-494-49-32
- Web Site: www.ua.zyxel.com
- Regular Mail: ZyXEL Ukraine, 13, Pimonenko Str., Kiev, 04050, Ukraine

United Kingdom

- Support E-mail: support@zyxel.co.uk
- Sales E-mail: sales@zyxel.co.uk
- Telephone: +44-1344 303044, 08707 555779 (UK only)
- Fax: +44-1344 303034
- Web Site: www.zyxel.co.uk
- FTP Site: [ftp.zyxel.co.uk](ftp://ftp.zyxel.co.uk)
- Regular Mail: ZyXEL Communications UK, Ltd., 11 The Courtyard, Eastern Road, Bracknell, Berkshire, RG12 2XB, United Kingdom (UK)

“+” is the (prefix) number you dial to make an international telephone call.

Index

Symbols

.NET Framework [17](#)

A

about screen [29](#)

Advanced Encryption Standard, see AES [13](#)

AES [15](#), [23](#)

AES (Advanced Encryption Standard) [13](#)

applications [13](#), [14](#)

C

cabling type [35](#)

CE [35](#)

certifications [35](#), [39](#)

notices [40](#)

viewing [40](#)

coaxial cable [14](#)

configuration screen [24](#)

configuration utility [14](#)

connections overview [13](#)

connections overview, over coaxial cable [14](#)

contact information [43](#)

copyright [39](#)

customer support [43](#)

D

DAK [24](#), [25](#)

DAK (Data Access Password) [15](#)

Data Access Password, see DAK [15](#)

dimensions [35](#)

disclaimer [39](#)

E

electrical and cable wiring [23](#)

electrical circuit boundaries [23](#)

encryption [13](#), [23](#), [35](#)

ETHN LED [31](#)

F

FCC [35](#)

FCC interference statement [39](#)

firmware [26](#)

firmware errors [27](#)

frequency band [35](#)

H

HomePlug AV standard [13](#)

humidity, operation and storage [35](#)

I

installation

overview [17](#)

procedure [17](#)

requirements [17](#)

InstallShield wizard [19](#)

introduction [13](#)

L

LED [31](#)

ETHN [31](#)

LINK [31](#)

PWR [31](#)

LINK LED [31](#)

local vs. remote adapter [25](#)

M

MAC address [25](#)
management [14](#)
 multiple networks [14](#)
 overview [23](#)
 privacy [14](#)

N

network example [23](#)
network information [28](#)
network ports [35](#)
number of devices supported [35](#)

P

Parameter Information Block, see [PIB 26](#)
passwords [24](#), [25](#), [26](#)
 types of [15](#)
PIB (Parameter Information Block) [26](#)
plug-and-play [23](#)
power specification [35](#)
private network [15](#)
problems and solutions [31](#)
product registration [41](#)
PWR LED [31](#)

R

receive rate [28](#)
registration
 customer information [20](#)
 product [41](#)
 user name [20](#)
related documentation [3](#)

S

safety warnings [5](#)
screws [36](#)
security [14](#), [24](#)
 passwords [15](#)

starting the utility [24](#)
syntax conventions [4](#)

T

temperature, operation and storage [35](#)
trademarks [39](#)
transfer rates [13](#)
transmit rate [28](#)
troubleshooting [31](#)

U

utility
 launching [24](#)

W

warranty [41](#)
 note [41](#)